

POLE SHAFT SPECIFICATIONS						
NO.						
1.	ROUND TAPERED POLE CONSTRUCTED OF THERMOSETTING RESIN REINFORCED WITH GLASS OR OTHER FIBERS OF SUCH QUANTITY AND ORIENTATION TO MEET OR EXCEED PERFORMANCE REQUIREMENT SET FORTH IN ANSI C136.20-2012. THE GLASS AND VEIL MATTING SHALL BY CENTRIFUGALLY SPUN WITH A REINFORCED RESIN MATRIX PER THE EXACT SPECIFICATIONS OF THE DESIGN. THE HAND HOLE AREA AND HARDWARE ATTACHMENT AREAS SHALL BE REINFORCED.					
2.	POLES SHALL HAVE A HIGHLY WEATHER-RESISTANT SURFACE FINISH IN COMPLIANCE WITH ANSI C136.20-2012					
POLE DIMENSIONS						
POLE HGT. (FT.)		TIP DIA. (IN.)		GROUNDLINE DIA. (IN.)		MTG. HGT. (FT.)
20'		3.0		6.2		16'
ALLOWABLE WIND LOADING (SQ. FT.)						
90 MPH	100 MPH	110 MPH	120 MPH	130 MPH	140 MPH	150 MPH
6.3	4.6	3.4	2.7	2.2	1.8	1.5

* WITH A 1.3 GUST FACTOR

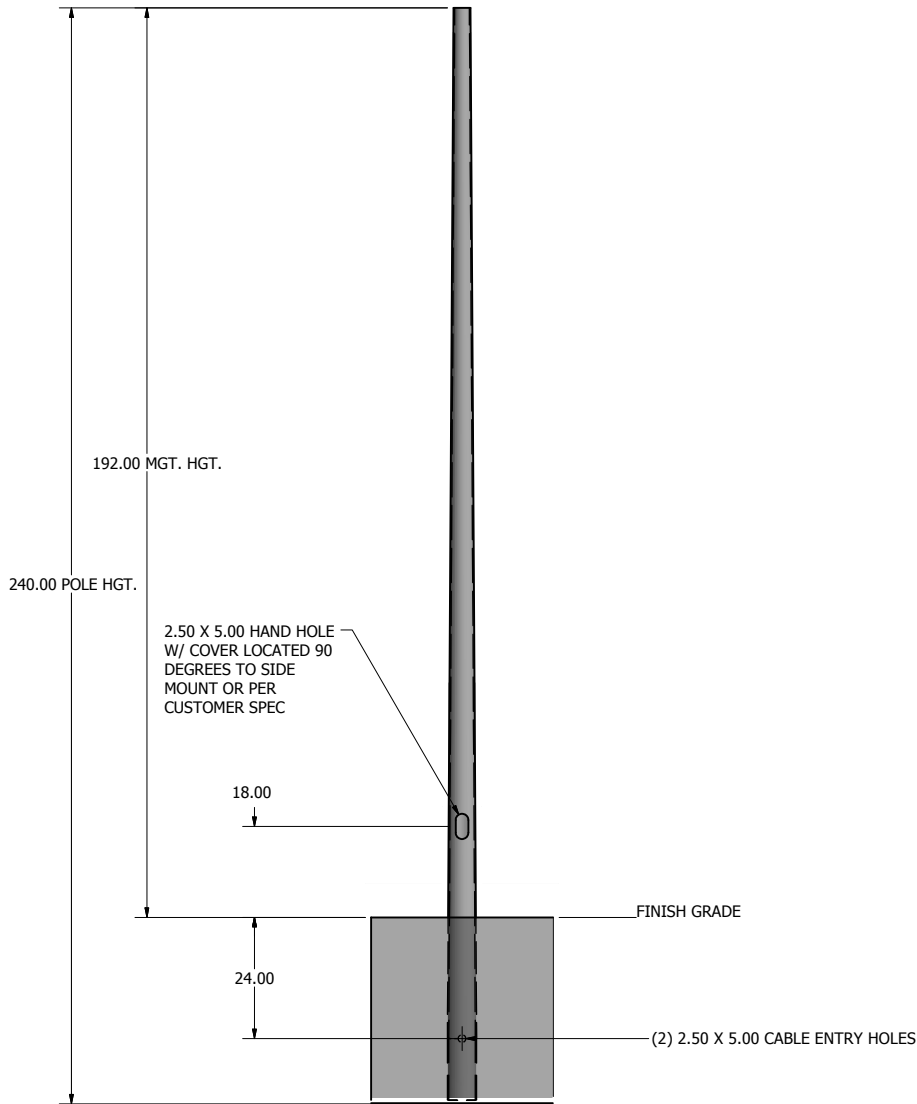

POLE DETAIL

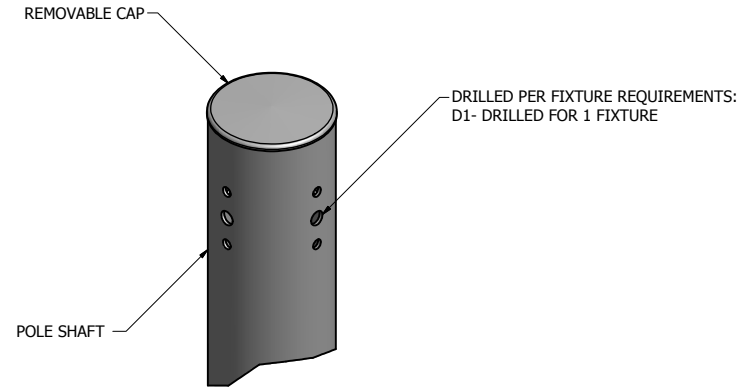

DRILL MOUNT OPTIONS

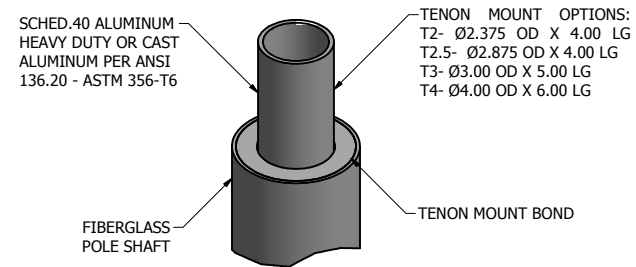

TENON MOUNT OPTIONS

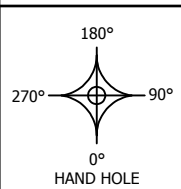

DRAWN: K. GUFFEY	8/12/2021
CHECKED:	
REVISION: 4	DATE: 2/05/2024
APPROVED:	
QUOTE:	
S.O.#	
REF:	SCALE: NONE



SOME GEOGRAPHICAL AREAS HAVE SPECIAL WIND CONDITIONS THAT CAN CREATE WIND INDUCED VIBRATIONS CAUSING A FATIGUE PROBLEM. NO METHOD HAS YET BEEN FOUND FOR PREDICTING DESTRUCTIVE LIGHTING POLE VIBRATION. THESE CONDITIONS ARE UNIQUE AND CANNOT BE GUARANTEED AGAINST, AND ARE THE RESPONSIBILITY OF A LOCAL SITE ENGINEER.

TITLE:		
CATALOG:		
DWG NO: 415-1-EMB-20	SIZE: C	SHEET 1 OF 1